

A 3000 Ns Sugar–Sodium Nitrate motor development for space education

Stancato, F.
Universidade do Norte do Paraná

Catalani Racca, J. G., Castaldo, F., Carbonari, G., Souza, L.A., Ballarotti, M.G.
Universidade Estadual de Londrina

Londrina, Paraná State - Brazil

ABSTRACT

A solid propellant motor was developed for use in two rocketry groups in Brazil: the Grupo de Foguetes Experimentais – GFE and the Núcleo de Atividades Aeroespaciais – NATA. The motor would fulfill the following characteristics:

- Reliability;
- Safety;
- No hazard propellant manipulations;
- Low cost firing;
- Capability to send a 12 Kg loaded rocket to a 2000 meters altitude;
- Reusability;
- No ambient aggressiveness;
- Easy loading and operation.

A 3000 Ns motor was built using sugar – sodium nitrate unrestricted burning unit, single hollow charge.

It is described the project development and qualification tests. A static test stand with digital acquisition system was developed and used.

The thrust curve was measured and a regressive burning characteristic was found, being ideal for short launch towers and low structural loads.

Although not extensively used in rocketry field the sugar - sodium nitrate propellant proved to be an excellent alternative for medium experimental rockets, especially for safe and low cost firing characteristics

INTRODUCTION

Copyright © 2000 by Fernando Stancato. Published by the American Institute of Aeronautics and Astronautics, Inc., with permission. Released to IAF/IAA/AIAA to publish in all forms.

In 1988 it was formed an experimental rocket group called “Grupo de Foguetes Experimentais” in order to make university and high school students apply their knowledge in Mathematics, Physics and Chemistry in the design, construction, tests

and launch of an experimental rocket. In 1995 it was developed the first successful 250 Ns solid propellant called M1. Soon an 750 Ns motor was developed with composite tube. These motors were used in more than 15 launches from 1995 to 2000. The rockets used in this launches had 63 mm in diameter, 1,5 to 1,8 meters in length and carried only a recovery system and an accelerometer.

At mid 1999 it was created an institution in the Universidade Estadual de Londrina called “Núcleo de Atividades Aeroespaciais” - NATA, with the same GFE objectives but now with students and teachers from the university.

The first project was an experimental rocket that would carry diverse instruments. The general characteristics was a 12 Kg loaded rocket with an apogee about 2000 meters. This led to an 3000 Ns motor. This motor would serve both NATA and GFE group.

As the objectives of both groups is to give a hands-on experience to the students on space area the motor would fulfill some requirements:

- No hazard propellant manipulations. As the propellant was going to be manufactured by the students a safe and non toxic materials was a necessity as we do not have specialized laboratory installations;
- Reliable. The manufacturing process must have not much restrictive properties margins as it was not going to be made by specialized professionals;
- Low cost. It would permit a great number of tests and launches without excessive propellant costs.
- Reusable. The motor hardware must permit a great number of firing.
- No ambient aggression. The burning gasses would have no toxic or ambient aggression characteristics.

It was decided for a solid propellant motor for its low cost hardware and rapid development. It was studied some modern composite propellants but the price and availability of some components made it unaffordable. It was decided to use the sugar-sodium nitrate for its low price, easy access reliability and safe manipulation. Development time would be shortened as the GFE had used it extensively in the M1 and M2 motors.

MOTOR DESIGN¹

Chamber Pressure, P_c

It is designed the initial chamber pressure as it was expected the thrust curve to be regressive as it was the same grain – motor geometry predecessor motors M1 and M2. The initial chamber pressure was choused as 20 Kgf/cm².

Grain

It was decided to use an unrestricted single hollow charge. Measurements of the specific impulse of this propellant in the M1 motor led to the value of 78 seconds.

The mass of the propellant, m_p can be calculated by:

$$m_p = I_t / (I_s \cdot g) \quad (1)$$

where:

I_t = Total impulse (N.s)

I_s = Specific impulse (s)

g = Gravitational constant (m/s²)

Using $I_t = 3200$ N.s and $I_s = 78$ s we get from equation (1) a total mass of 4.180 Kg of propellant. Using propellant density value of 1.73 g/cm³ a grain was calculated:

External Diameter: 79 mm
 Internal Diameter: 10 mm
 Length: 51 mm
 Burning Area: 1,402.25 cm²

Initial linear burning rate

Using a correlation from STANCATO, 1997²:

$$r_o = 0,0728 \cdot P_c^{0,5098} \quad (2)$$

where:

r_o = linear burning rate (cm/s)
 P_c = Chamber Pressure (Kgf/cm²)

Using a chamber pressure of 20 Kgf/cm², from equation (2) we have a burning rate of 0.3353 cm/s.

Eroding burning rate

It was found with tests of small motors (STANCATO, 1997)² with unrestricted grain that a pronounced erosive burn occurs, specially at the beginning of the burning as the M1 and M2 motors had a initial small port area. It was found that an erosion coefficient (ϵ) must be used for correct burning rate estimation:

$$\epsilon = r/r_o \quad (3)$$

where:

r = eroding burning rate
 r_o = linear burning rate without gas flow parallel to its surface.

In many static and dynamic tests it was found an value of 1.4 for the erosion coefficient. Using equation (3) we have an r value of 0.4694 cm/s.

Gas mass flow, m_g

The gas mass flow that passes through the nozzle is

$$m_g = X \cdot r \cdot \rho \cdot A_b \quad (4)$$

where:

Mass fraction of gasses in the exhaust, $X = 0.7894$ (STANCATO, 1997)²

Eroding burning rate, $r = 0.4694$ cm/s

Propellant specific mass, $\rho = 1.73$ g/cm³

Burning area, $A_b = 1,402.25$ cm²

From equation (4) and the above values, the $m_g = 0.899$ Kg/s.

Throat Area, A_t

The throat area can be calculated by:

$$A_t = \frac{m_g \cdot X \cdot (\gamma \cdot T_c \cdot R/M)^{1/2}}{\Gamma \cdot P_c} \quad (5)$$

where:

γ = ratio of specific heats,
 T_c = combustion temperature
 R = universal gas constant
 M = molecular weight of gas products
 $\Gamma = \gamma(2/\gamma+1)^{(\gamma+1)/2(\gamma-1)}$

Press. (atm)	T_c (K)	γ	X	M	Γ	C_f
5	1550	1,1791	0,8402	27,83	0,7004	1,089
10	1615	1,1712	0,8145	27,62	0,6998	1,270
20	1677	1,1639	0,7894	27,42	0,6924	1,416
40	1732	1,1578	0,7672	27,30	0,6882	1,539
100	1785	1,1519	0,7434	26,97	0,6858	1,675
150	1802	1,1501	0,7362	26,90	0,6849	1,728
200	1811	1,1491	0,7321	26,85	0,6844	1,762

Obs.: C_f = Thrust Coefficient

Table 1: Thermodynamic exhaust gases properties for different pressures.

Evaluating the gasses properties at 20 Kg/cm² we have an throat area of 5 cm² or a throat diameter of 25.4 mm.

$$e \geq \frac{(2,026E6) \cdot (4,8E - 2) \cdot (7)}{(350E6)}$$

$$e \geq 1,94mm \quad e = 2mm$$

Motor designing considerations

The motor wall thickness was calculated using simplified criteria of Strength of Materials for cylindrical tanks submitted to internal pressure, within the elastic limit.

Discontinuity stresses – additional stresses in edge junctions due to deformations of cylinder radius and of closing cover – were unconsidered in calculation. Longitudinal stresses are not dependent on edges shape and were half of circumferential stresses. Therefore, circumferential stresses σ_{θ} are the main and it values³:

$$\sigma_{\theta} = \frac{p \cdot R}{e} \quad (6)$$

where:

- p = chamber internal pressure;
- R = external radius of motor cylinder;
- e = thickness of wall;

Data:

- Carbon steel ST-51;
- Yield strength of steel $f_{yk} = 350$ MPa;
- Internal pressure of project = 20 Kg/cm² (2,026 MPa);
- Cylinder radius R = 48 mm;
- safety factor adopted $s = 7$;

from equation (6):

$$\frac{p \cdot R}{e} \leq \frac{f_{yk}}{s}$$

$$e \geq \frac{p \cdot R \cdot s}{f_{yk}}$$

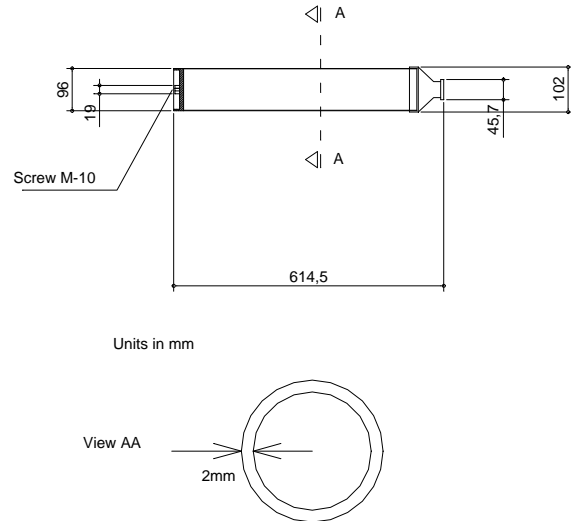

Fig. 1. Schematic motor drawing

PROPELLANT MANUFACTURING

The following are the steps for manufacturing the propellant which will be used for testing and launching:

- pounding the sodium nitrate
- mixing and to drying the mixture of sodium nitrate and with sugar
- Melting and molding the caramel

Pounding the sodium nitrate

Materials used: blender, pestle and moar, pan, long glass rod, paper for pan cleaning and drying, knife to open the packs of sodium nitrate.

Preparing the mixture

The proportion used in the compound was 60% of sodium nitrate (NaNO₃ – combustible) and 40% of sacarose (oxidant)⁴. From 5 Kg of material used,

there were 3 Kg of Sodium Nitrate and 2 Kg of refined sugar. The nitrate was pounded using a blender. The powder portion was put inside a pan. The grains that still remained together were pounded in the mortar with the pestle. The powder of sodium nitrate retains humidity very easy and part of it remained stucked in the blender cup. To remove these it was used the long glass rod.

Mixing and drying the sodium nitrate with sugar

Procedures: it was used a digital balance to check the compound ingredients mass (3kg of sodium nitrate and 2 kg of refined sugar). Both of them were put into a pan for mixing. It was used a mechanic mixer to have a better homogenization of the combustible and the oxidant. The humid mass of the sodium nitrate and sugar was 5012 g.

The mixture was taken into a stove where it stayed for approximately 2 hours under a temperature of 80° . Then it was put again in the mechanic mixer, and right after that the mixture were passed through a 16 sieve. The portion retained in the sieve was pounded with the flat head pestle.

Melting and molding the caramel

Materials used: 1 industrial stove, 2 pans, 2 vegetal oil cubes, 1 gas bottle, 2 long wooden spoons, 3 pairs of leather gloves, a penknife, adhesive tape, transparencies, 1 screwdriver, black powder in the top of the caramel in the mould, cylindrical metallic mould to give the caramel cylindrical shape.

Procedures: initially it was prepared the steel mould in which was inserted the melted compound.

The mould has an internal haste, which was revolved with aluminum foil, to make easier to get it out.

One layer of transparencies was put into the cylindrical mould.

Once the mould is ready it was begun the heating of the oil in the "recipients". The

compound (5 kg) was divided in two pans, which were put into the recipients with heated oil. It is necessary to keep mixing the material with the wooden spoons during the heating process to avoid scorching the compound .

Once the mixture become a caramel (when all the mixture melts), it was put into the mould. After that the mould was involved with common plastic and aluminum foil to insulate it and to avoid the absorption of humidity during the solidification process.

ROCKET MOTOR STATIC TESTING

To obtain an estimate of the maximum thrust, a simple, highly portable and protected bench was constructed in steel with 4 mm thickness. The axial and vertical motor movement was allowed to avoid secondary forces interference in the test.



Fig. 2. The rocket motor was mounted vertically, with the nozzle facing upward, in a metallic holder

A load cell used for applied forces until 20,000N was installed in the bench and connected with an electronic Acquisition Signal System.

Within of laboratory room specially designed for this test, there were a TV monitor, the acquisition signal system and the motor ignition system control.



Fig. 3. Laboratory data acquisition system and test control

Acquisition Signal System

A Signal acquisition system based on the system ADS2000 is shown in fig.4 . In such scheme the motor applies force down over a load cell as the propellant burns. The exerted force over the load cell strain the gages and a small voltage signal proportional to the strength is generated by the load cell. The amplitude of this signal varies in mV range. A next signal conditioner amplifies the generated signal to a suitable amplitude before applying it to the A/D interface. Another signal adjustments are also carried out by the Signal Conditioner as filtering and galvanic isolation. In such arrangement only one of the AI2160 channels is used.

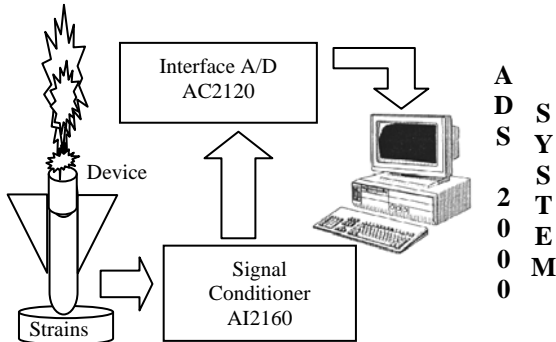

Fig. 4. Signal Acquisition System

The A/D interface converts the well-fitted input analog signal into binary format that can be recognized by a computer-based system. The 12-bits conversion process based on successive-approach scheme fits all the requirements concerned to conversion time allowing time-variable signals as fast as by tens of KHz being sampled. In such essay the sampling rate was 5000 points a second, a good agreement between results accuracy and file storage size on a computer in events up to some dozens lasting. Such sampling rates prevents also the aliasing effect. After signal conversion the electrical equivalent input acquired from the load cell becomes a digital word and can be sent to the computer through parallel interface. The next step the software reads the measured points and shows them into a adequate physical amount on a display. In this essay, the related physical amount were force given in Kilogram-force and elapsed time given in seconds. The software also features handling and showing data capability allowing the user to get information concerning the subject under investigation.

The figure 5 shows a kind of connecting the load cell to the AI2160 input. Note the Whetstone configuration used. As the range of applied strength gets up to one thousand of Kilogram-Force, the electrical equivalent output varies into some dozens of milivolts range when 10 V supply is used. An additional signal amplification of 600 can be set by the user provided in the AI2160 control adjusts to the present experiment.

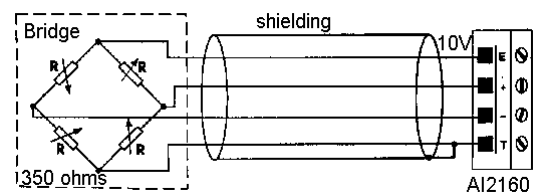

Fig. 5. Connecting the load cell to the Conditioner

As result of such arrangement an output electrical signal ranging between 0 and 5 V is therefore sent to the A/D Interface. After conversion and sending data through parallel interface to the computer the software sets

the scale factor so the physical amounts can be read out directly on graphic displays as shown in figure 6. To do so a calibration process should be carried out before the experiment takes place.

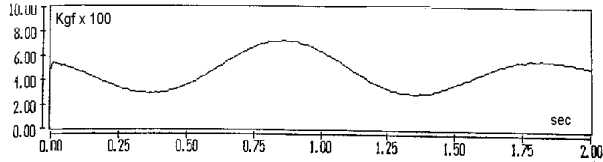

Fig. 6. Visualizing a physical amount time-varying waveform

Calibration Process: After properly operation of the acquisition system a calibration process can be launched prior the beginning of the experiment. The goal of this process relies on setting both an upper and lower physical amount in accordance with the signal range sent to the A/D converter so an adequate display of the physical amount (e.g. Force) can be read out as shown in figure 7.

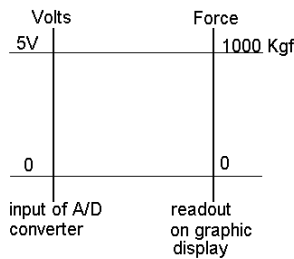

Fig. 7. Correlation between A/D converter input and physical amount

However this signal range can be settled by the user by adjusting Signal Conditioner controls the user should know about the relationship between the output voltage range picked up from the transducer (e.g. load cell) and the physical amount applied to it. The calibration process demands a kind of adjustment called "Linear Regression" where some measured points are entered and another ones are calculated by interpolation. A best correlation between the actual values of the physical amounts and the measured ones takes place in such scheme. This process also prevents from inaccuracies of

the whole system. To perform the calibration process the user just apply some known values of the physical amount (e.g. standard weights) to the transducer and relates them to the computer in a look-up table that will be used to calculate the correlation afterwards. The figure 8 shows a window launched to execute this operation. Once completed the system is ready to proper operation.

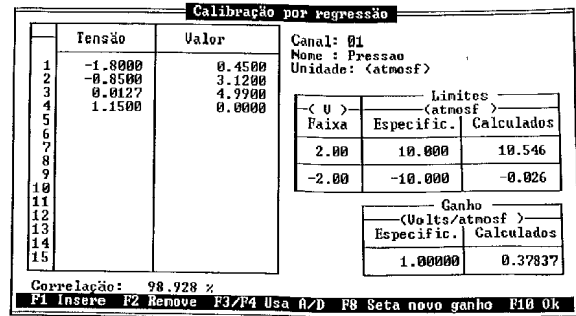

Fig. 8. Window for calibration

Thrust-time curve

Total impulse (I_t) is defined as the integral of the thrust (F) over the operating duration (t) of the motor:

$$I_t = \int_0^t F dt \quad (7)$$

The obtained curve from static testing indicated a thrust maximum of 1,540 N and a total impulse of 2,874 Ns.

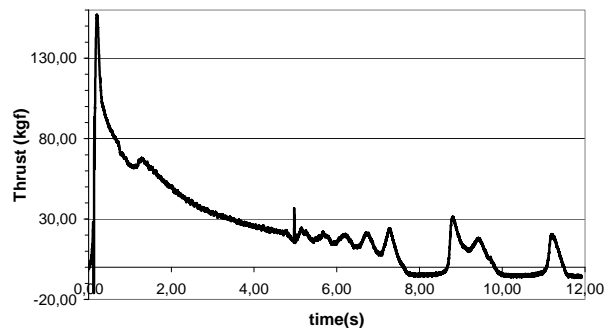

Fig. 9. Motor thrust curve

MOTOR THRUST FROM FLIGHT
ANALYSIS

The idea of constructing the engine thrust curve (of motor M3) from data of flight appeared with the launch of Cabral rocket. 2.6 m long, weighting 14.185 Kg, 10 cm of diameter, 4.135 Kg of propellant mass, Cabral got an apogee of 1,900 m. Cabral rocket flew in April 24 of 2000. There was an onboard system to acquire acceleration, velocity and altitude data of all flight.



Fig. 10. Cabral's lift-off

The thrust curve of the motor is obtained from these data. Using Newton's first law,

$$F = m \cdot (a + g) + F_D \quad (8)$$

where:

- F = motor thrust (N)
- m = mass of rocket (Kg)
- a = acceleration (m/s²)
- F_D = drag force (N)

and

$$F_D = \frac{C_D \cdot \rho \cdot A \cdot v^2}{2} \quad (9)$$

where⁵:

- C_D = drag coefficient;
- ρ = air density (Kg/m³);
- A = sectional area (m²);
- v = velocity (m/s);

and

$$\rho = 1,2308 \cdot e^{(-0.000101741 \cdot h)} \quad (10)$$

where⁵:

- h = altitude (m);

the unique unknown variable will be the mass of the rocket (m) that changes during the flight.

As the gas mass flow is proportional to acceleration², the consumed propellant mass can be calculated by:

$$m_{cons_t} = \frac{\sum_0^t a}{\sum_0^{tf} a} \cdot m_{prop} \quad (11)$$

where:

- m_{cons_t} = consumed mass until time t (Kg)

- ∑₀^t a = sum of accelerations values from t = 0 until time t

- ∑₀^{tf} a = sum of sum of accelerations values from t = 0 until burnout

- m_{prop} = total propellant mass (Kg)

The curve below resulted in 3220 Ns of total impulse.

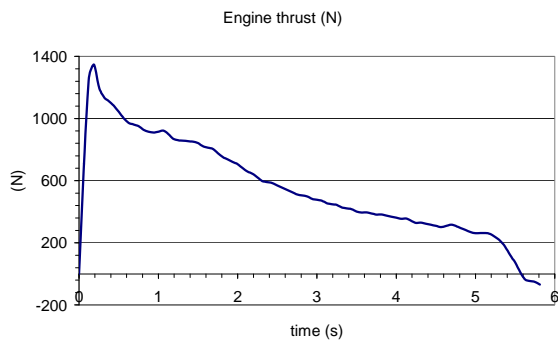

Fig. 11. Motor thrust curve of M3 from Cabral's flight

CONCLUSION

Although the motor had a shuffling effect in the static test the total impulse on both static and flight was about the expected 3,000 Ns.

A regressive thrust curve was obtained on both test being a good characteristic for experimental rocket launch where short launch rail can be used.

Although not extensively used in rocketry the sugar-sodium nitrate propellant proved to be an excellent alternative for medium experimental rockets, specially for safe and low cost firing characteristics.

REFERENCES

1. SUTTON, George P. – “Rocket Propulsion Elements - An Introduction to the Engineering of Rockets”. New York, John Wiley & Sons, INC., 1965, 466 p.

2. STANCATO, Fernando and MIRAGLIA, José– “Internal Ballistic Principles a Methodology and an Experimental Didactic Experimentation.” – International Mobility Technology Conference and Exhibit, São Paulo, Brasil, October 27-29, 1997. SAE paper n. 973087P.

3. TIMOSHENKO, Stephen P., “Strength of Materials”, D. Van Nostrand Company, Inc., 1930

4. VYVERMAN, Tony – “The potassiumnitrate - sugar propellant.” A Workinggroup Propulsion publication, 1978.

5. ROBERSON, John A., CROWE, Clayton T., “Engineering Fluid Mechanics”, Houghton Mifflin Company, 1975.