

Eigenvalues and Eigenvectors

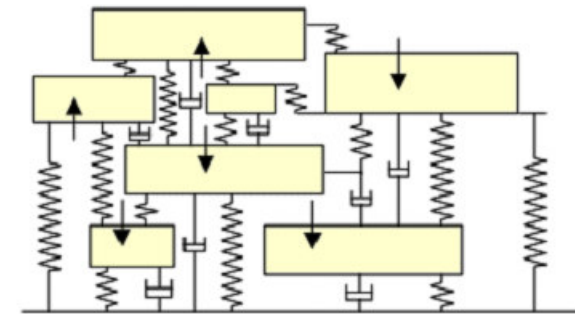

(Copyright © Brüel & Kjær)

In this chapter we will focus on classes of scalars and vectors known as “eigenvalues” and “eigenvectors,” terms derived from the German word *eigen*, meaning “own,” “peculiar to,” “characteristic,” or “individual.” The underlying idea first appeared in the study of rotational motion but was later used to classify various kinds of surfaces and to describe solutions of certain differential equations. In the early 1900s it was applied to matrices and matrix transformations, and today it has applications in such diverse fields as computer graphics, mechanical vibrations, heat flow, population dynamics, quantum mechanics, and economics, to name just a few.

source: *Elementary Linear Algebra*, H. Anton / C. Rorres
Copyright © 2014 John Wiley & Sons, Inc.

Definition of Eigenvalue and Eigenvector

DEFINITION 1 If A is an $n \times n$ matrix, then a nonzero vector \mathbf{x} in R^n is called an *eigenvector* of A (or of the matrix operator T_A) if $A\mathbf{x}$ is a scalar multiple of \mathbf{x} ; that is,

$$A\mathbf{x} = \lambda\mathbf{x}$$

for some scalar λ . The scalar λ is called an *eigenvalue* of A (or of T_A), and \mathbf{x} is said to be an *eigenvector corresponding to λ* .

The requirement that an eigenvector be nonzero is imposed to avoid the unimportant case $A\mathbf{0} = \lambda\mathbf{0}$, which holds for every A and λ .

In general, the image of a vector \mathbf{x} under multiplication by a square matrix A differs from \mathbf{x} in both magnitude and direction. However, in the special case where \mathbf{x} is an eigenvector of A , multiplication by A leaves the direction unchanged.

For example, in R^2 or R^3 multiplication by A maps each eigenvector \mathbf{x} of A (if any) along the same line through the origin as \mathbf{x} . Depending on the sign and magnitude of the eigenvalue λ corresponding to \mathbf{x} , the operation $A\mathbf{x} = \lambda\mathbf{x}$ compresses or stretches \mathbf{x} by a factor of λ , with a reversal of direction in the case where λ is negative (Figure 5.1.1).

► Figure 5.1.1

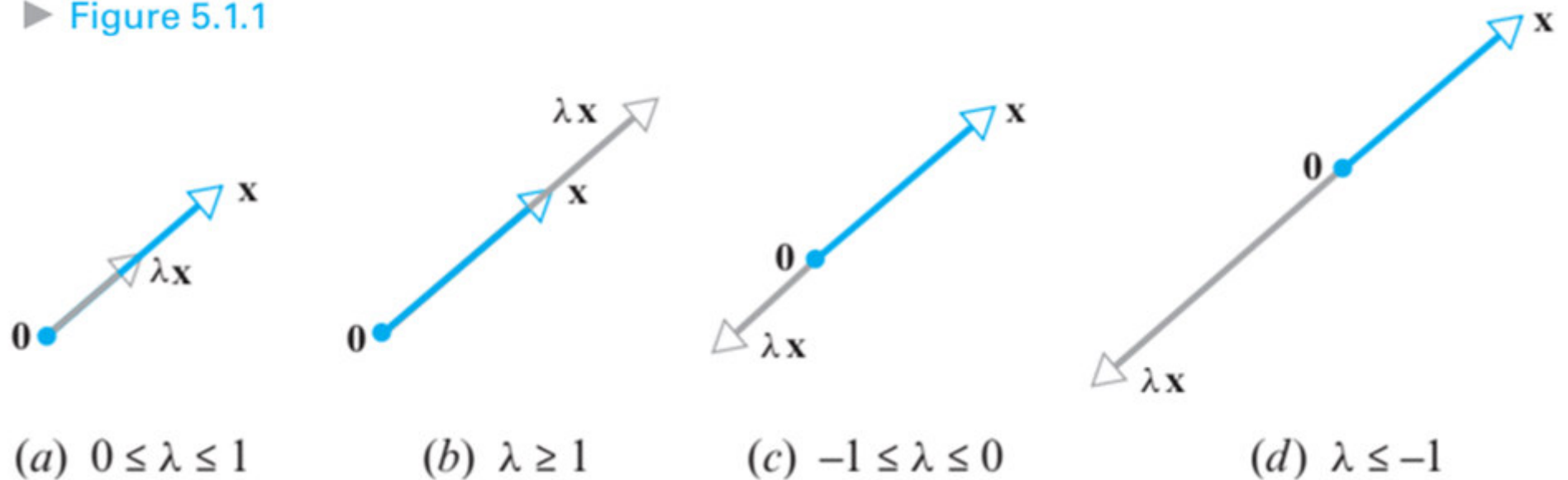

► **EXAMPLE 1 Eigenvector of a 2 × 2 Matrix**

The vector $\mathbf{x} = \begin{bmatrix} 1 \\ 2 \end{bmatrix}$ is an eigenvector of

$$A = \begin{bmatrix} 3 & 0 \\ 8 & -1 \end{bmatrix}$$

corresponding to the eigenvalue $\lambda = 3$, since

$$A\mathbf{x} = \begin{bmatrix} 3 & 0 \\ 8 & -1 \end{bmatrix} \begin{bmatrix} 1 \\ 2 \end{bmatrix} = \begin{bmatrix} 3 \\ 6 \end{bmatrix} = 3\mathbf{x}$$

Geometrically, multiplication by A has stretched the vector \mathbf{x} by a factor of 3 (Figure 5.1.2). ◀

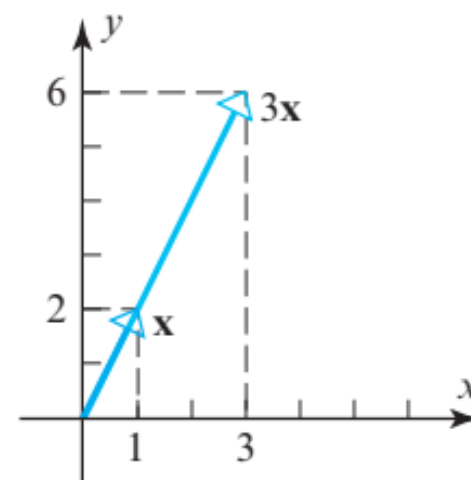

▲ Figure 5.1.2

Determination of Eigenvalues and Eigenvectors

We illustrate all the steps in terms of the matrix

$$\mathbf{A} = \begin{bmatrix} -5 & 2 \\ 2 & -2 \end{bmatrix}.$$

Solution. (a) *Eigenvalues.* These must be determined *first*. Equation (1) is

$$(1) \quad \mathbf{Ax} = \begin{bmatrix} -5 & 2 \\ 2 & -2 \end{bmatrix} \begin{bmatrix} x_1 \\ x_2 \end{bmatrix} = \lambda \begin{bmatrix} x_1 \\ x_2 \end{bmatrix}; \quad \text{in components,} \quad \begin{aligned} -5x_1 + 2x_2 &= \lambda x_1 \\ 2x_1 - 2x_2 &= \lambda x_2. \end{aligned}$$

Transferring the terms on the right to the left, we get

$$(2^*) \quad \begin{aligned} (-5 - \lambda)x_1 + 2x_2 &= 0 \\ 2x_1 + (-2 - \lambda)x_2 &= 0. \end{aligned}$$

This can be written in matrix notation

$$(3^*) \quad (\mathbf{A} - \lambda \mathbf{I})\mathbf{x} = \mathbf{0}$$

because (1) is $\mathbf{Ax} - \lambda\mathbf{x} = \mathbf{Ax} - \lambda\mathbf{Ix} = (\mathbf{A} - \lambda\mathbf{I})\mathbf{x} = \mathbf{0}$, which gives (3*).

We see that this is a *homogeneous* linear system.

It has a nontrivial solution $\mathbf{x} \neq \mathbf{0}$ (an eigenvector of \mathbf{A} we are looking for) if and only if its coefficient determinant is zero, that is,

characteristic
equation

$$(4^*) \quad D(\lambda) = \det(\mathbf{A} - \lambda\mathbf{I}) = \begin{vmatrix} -5 - \lambda & 2 \\ 2 & -2 - \lambda \end{vmatrix} = (-5 - \lambda)(-2 - \lambda) - 4 = \lambda^2 + 7\lambda + 6 = 0.$$

characteristic
matrix

characteristic
determinant

characteristic
polynomial

The solutions of this quadratic equation are $\lambda_1 = -1$ and $\lambda_2 = -6$.

These are the eigenvalues of \mathbf{A} .

(b₁) Eigenvector of A corresponding to λ_1 .

This vector is obtained from (2*) with $\lambda = \lambda_1 = -1$, that is,

$$-4x_1 + 2x_2 = 0$$

$$2x_1 - x_2 = 0.$$

A solution is $x_2 = 2x_1$, as we see from either of the two equations, so that we need only one of them. This determines an eigenvector corresponding to $\lambda_1 = -1$ up to a scalar multiple.

If we choose $x_1 = 1$, we obtain the eigenvector

$$\mathbf{x}_1 = \begin{bmatrix} 1 \\ 2 \end{bmatrix}. \quad \text{Check:} \quad \mathbf{A}\mathbf{x}_1 = \begin{bmatrix} -5 & 2 \\ 2 & -2 \end{bmatrix} \begin{bmatrix} 1 \\ 2 \end{bmatrix} = \begin{bmatrix} -1 \\ -2 \end{bmatrix} = (-1)\mathbf{x}_1 = \lambda_1\mathbf{x}_1.$$

(b₂) *Eigenvector of A corresponding to λ_2 .* For $\lambda = \lambda_2 = -6$, equation (2*) becomes

$$x_1 + 2x_2 = 0$$

$$2x_1 + 4x_2 = 0.$$

A solution is $x_2 = -x_1/2$ with arbitrary x_1 . If we choose $x_1 = 2$, we get $x_2 = -1$.

Thus an eigenvector of A corresponding to $\lambda_2 = -6$ is

$$\mathbf{x}_2 = \begin{bmatrix} 2 \\ -1 \end{bmatrix}. \quad \text{Check:} \quad \mathbf{Ax}_2 = \begin{bmatrix} -5 & 2 \\ 2 & -2 \end{bmatrix} \begin{bmatrix} 2 \\ -1 \end{bmatrix} = \begin{bmatrix} -12 \\ 6 \end{bmatrix} = (-6)\mathbf{x}_2 = \lambda_2\mathbf{x}_2.$$

This example illustrates the general case as follows. Equation (1) written in components is

$$a_{11}x_1 + \cdots + a_{1n}x_n = \lambda x_1$$

$$a_{21}x_1 + \cdots + a_{2n}x_n = \lambda x_2$$

.....

$$a_{n1}x_1 + \cdots + a_{nn}x_n = \lambda x_n.$$

$$(1) \quad \mathbf{Ax} = \lambda \mathbf{x}.$$

Transferring the terms on the right side to the left side, we have

$$(a_{11} - \lambda)x_1 + a_{12}x_2 + \cdots + a_{1n}x_n = 0$$

$$(2) \quad a_{21}x_1 + (a_{22} - \lambda)x_2 + \cdots + a_{2n}x_n = 0$$

.....

$$a_{n1}x_1 + a_{n2}x_2 + \cdots + (a_{nn} - \lambda)x_n = 0.$$

In matrix notation,

$$(3) \quad (\mathbf{A} - \lambda \mathbf{I})\mathbf{x} = \mathbf{0}.$$

This homogeneous linear system of equations has a nontrivial solution if and only if the corresponding determinant of the coefficients is zero:

$$(4) \quad D(\lambda) = \det(\mathbf{A} - \lambda\mathbf{I}) = \begin{vmatrix} a_{11} - \lambda & a_{12} & \cdots & a_{1n} \\ a_{21} & a_{22} - \lambda & \cdots & a_{2n} \\ \cdot & \cdot & \cdots & \cdot \\ a_{n1} & a_{n2} & \cdots & a_{nn} - \lambda \end{vmatrix} = 0.$$

$\mathbf{A} - \lambda\mathbf{I}$ is called the **characteristic matrix** and $D(\lambda)$ the **characteristic determinant** of \mathbf{A} . Equation (4) is called the **characteristic equation** of \mathbf{A} . By developing $D(\lambda)$ we obtain a polynomial of n th degree in λ . This is called the **characteristic polynomial** of \mathbf{A} .

Computing Eigenvalues and Eigenvectors

Note that the equation $A\mathbf{x} = \lambda\mathbf{x}$ can be rewritten as $A\mathbf{x} = \lambda I\mathbf{x}$, or equivalently, as

$$(\lambda I - A)\mathbf{x} = \mathbf{0}$$

For λ to be an eigenvalue of A this equation must have a nonzero solution for \mathbf{x} . But this is so if and only if the coefficient matrix $\lambda I - A$ has a zero determinant.

THEOREM 5.1.1 *If A is an $n \times n$ matrix, then λ is an eigenvalue of A if and only if it satisfies the equation*

$$\det(\lambda I - A) = 0 \tag{1}$$

*This is called the **characteristic equation** of A .*

Note that if $(A)_{ij} = a_{ij}$, then formula (1) can be written in expanded form as

$$\begin{vmatrix} \lambda - a_{11} & a_{12} & \cdots & -a_{1n} \\ -a_{21} & \lambda - a_{22} & \cdots & -a_{2n} \\ \vdots & \vdots & & \vdots \\ -a_{n1} & -a_{n2} & \cdots & \lambda - a_{nn} \end{vmatrix} = 0$$

► **EXAMPLE 2 Finding Eigenvalues**

In Example 1 we observed that $\lambda = 3$ is an eigenvalue of the matrix

$$A = \begin{bmatrix} 3 & 0 \\ 8 & -1 \end{bmatrix}$$

but we did not explain how we found it. Use the characteristic equation to find all eigenvalues of this matrix.

Solution It follows from Formula (1) that the eigenvalues of A are the solutions of the equation $\det(\lambda I - A) = 0$, which we can write as

$$\begin{vmatrix} \lambda - 3 & 0 \\ -8 & \lambda + 1 \end{vmatrix} = 0$$

from which we obtain

$$(\lambda - 3)(\lambda + 1) = 0 \tag{2}$$

This shows that the eigenvalues of A are $\lambda = 3$ and $\lambda = -1$. Thus, in addition to the eigenvalue $\lambda = 3$ noted in Example 1, we have discovered a second eigenvalue $\lambda = -1$. ◀

When the determinant $\det(\lambda I - A)$ in (1) is expanded, the characteristic equation of A takes the form

$$\lambda^n + c_1\lambda^{n-1} + \cdots + c_n = 0 \quad (3)$$

where the left side of this equation is a polynomial of degree n in which the coefficient of λ^n is 1 (Exercise 37). The polynomial

$$p(\lambda) = \lambda^n + c_1\lambda^{n-1} + \cdots + c_n \quad (4)$$

is called the *characteristic polynomial* of A . For example, it follows from (2) that the characteristic polynomial of the 2×2 matrix in Example 2 is

$$p(\lambda) = (\lambda - 3)(\lambda + 1) = \lambda^2 - 2\lambda - 3$$

which is a polynomial of degree 2.

Since a polynomial of degree n has at most n distinct roots, it follows from (3) that the characteristic equation of an $n \times n$ matrix A has at most n distinct solutions and consequently the matrix has at most n distinct eigenvalues.

Since some of these solutions may be complex numbers, it is possible for a matrix to have complex eigenvalues, even if that matrix itself has real entries.

We will now focus on examples in which the eigenvalues are real numbers.

► **EXAMPLE 3 Eigenvalues of a 3 × 3 Matrix**

Find the eigenvalues of

$$A = \begin{bmatrix} 0 & 1 & 0 \\ 0 & 0 & 1 \\ 4 & -17 & 8 \end{bmatrix}$$

Solution The characteristic polynomial of A is

$$\det(\lambda I - A) = \det \begin{bmatrix} \lambda & -1 & 0 \\ 0 & \lambda & -1 \\ -4 & 17 & \lambda - 8 \end{bmatrix} = \lambda^3 - 8\lambda^2 + 17\lambda - 4$$

The eigenvalues of A must therefore satisfy the cubic equation

$$\lambda^3 - 8\lambda^2 + 17\lambda - 4 = 0 \tag{5}$$

To solve this equation, we will begin by searching for integer solutions. This task can be simplified by exploiting the fact that all integer solutions (if there are any) of a polynomial equation with *integer coefficients*

$$\lambda^n + c_1\lambda^{n-1} + \cdots + c_n = 0$$

must be divisors of the constant term, c_n . Thus, the only possible integer solutions of (5) are the divisors of -4 , that is, $\pm 1, \pm 2, \pm 4$. Successively substituting these values in (5) shows that $\lambda = 4$ is an integer solution and hence that $\lambda - 4$ is a factor of the left side of (5). Dividing $\lambda - 4$ into $\lambda^3 - 8\lambda^2 + 17\lambda - 4$ shows that (5) can be rewritten as

$$(\lambda - 4)(\lambda^2 - 4\lambda + 1) = 0$$



Thus, the remaining solutions of (5) satisfy the quadratic equation

$$\lambda^2 - 4\lambda + 1 = 0$$

which can be solved by the quadratic formula. Thus, the eigenvalues of A are

$$\lambda = 4, \quad \lambda = 2 + \sqrt{3}, \quad \text{and} \quad \lambda = 2 - \sqrt{3}$$

In applications involving large matrices it is often not feasible to compute the characteristic equation directly, so other methods must be used to find eigenvalues.

ALGEBRAIC MULTIPLICITY

When you try to factor a characteristic polynomial

$$\det(\lambda I - A) = \lambda^n + c_1\lambda^{n-1} + \cdots + c_n$$

one of three things can happen:

1. It may be possible to factor the polynomial completely into distinct linear factors using only real numbers; for example,

$$\lambda^3 + \lambda^2 - 2\lambda = \lambda(\lambda^2 + \lambda - 2) = \lambda(\lambda - 1)(\lambda + 2)$$

2. It may be possible to factor the polynomial completely into linear factors using only real numbers, but some of the factors may be repeated; for example,

$$\lambda^6 - 3\lambda^4 + 2\lambda^3 = \lambda^3(\lambda^3 - 3\lambda + 2) = \lambda^3(\lambda - 1)^2(\lambda + 2)$$

3. It may be possible to factor the polynomial completely into linear and quadratic factors using only real numbers, but it may not be possible to decompose the quadratic factors into linear factors without using imaginary numbers (such quadratic factors are said to be *irreducible* over the real numbers); for example,

$$\lambda^4 - 1 = (\lambda^2 - 1)(\lambda^2 + 1) = (\lambda - 1)(\lambda + 1)(\lambda - i)(\lambda + i)$$

Here the factor $\lambda^2 + 1$ is irreducible over the real numbers.

It can be proved that if imaginary eigenvalues are allowed, then the characteristic polynomial of an $n \times n$ matrix A can be factored as

$$\det(\lambda I - A) = \lambda^n + c_1\lambda^{n-1} + \dots + c_n = (\lambda - \lambda_1)(\lambda - \lambda_2) \cdots (\lambda - \lambda_n) \quad (18)$$

where $\lambda_1, \lambda_2, \dots, \lambda_n$ are eigenvalues of A .

This is called the *complete linear factorization* of the characteristic polynomial.

If some of the factors in (18) are repeated, then they can be combined; for example, if the first k factors are distinct and the rest are repetitions of the first k , then (18) can be rewritten in the form

$$\det(\lambda I - A) = \lambda^n + c_1\lambda^{n-1} + \cdots + c_n = (\lambda - \lambda_1)^{m_1}(\lambda - \lambda_2)^{m_2} \cdots (\lambda - \lambda_k)^{m_k} \quad (19)$$

where $\lambda_1, \lambda_2, \dots, \lambda_k$ are the *distinct* eigenvalues of A .

The exponent m_i , called the *algebraic multiplicity* of the eigenvalue λ_i , tells how many times that eigenvalue is repeated in the complete factorization of the characteristic polynomial.

The sum of the algebraic multiplicities of the eigenvalues in (19) must be n , since the characteristic polynomial has degree n .

For example, if A is a 6×6 matrix whose characteristic polynomial is

$$\lambda^6 - 3\lambda^4 + 2\lambda^3 = \lambda^3(\lambda^3 - 3\lambda + 2) = \lambda^3(\lambda - 1)^2(\lambda + 2)$$

then the distinct eigenvalues of A are $\lambda = 0$, $\lambda = 1$, and $\lambda = -2$.

The algebraic multiplicities of these eigenvalues are 3, 2, and 1, respectively, which sum up to 6 as required.

THEOREM 5.1.2 *If A is an $n \times n$ triangular matrix (upper triangular, lower triangular, or diagonal), then the eigenvalues of A are the entries on the main diagonal of A .*

► **EXAMPLE 4 Eigenvalues of an Upper Triangular Matrix**

Find the eigenvalues of the upper triangular matrix

$$A = \begin{bmatrix} a_{11} & a_{12} & a_{13} & a_{14} \\ 0 & a_{22} & a_{23} & a_{24} \\ 0 & 0 & a_{33} & a_{34} \\ 0 & 0 & 0 & a_{44} \end{bmatrix}$$

$$A = \begin{bmatrix} a_{11} & a_{12} & a_{13} & a_{14} \\ 0 & a_{22} & a_{23} & a_{24} \\ 0 & 0 & a_{33} & a_{34} \\ 0 & 0 & 0 & a_{44} \end{bmatrix}$$

Solution Recalling that the determinant of a triangular matrix is the product of the entries on the main diagonal (Theorem 2.1.2), we obtain

$$\begin{aligned} \det(\lambda I - A) &= \det \begin{bmatrix} \lambda - a_{11} & -a_{12} & -a_{13} & -a_{14} \\ 0 & \lambda - a_{22} & -a_{23} & -a_{24} \\ 0 & 0 & \lambda - a_{33} & -a_{34} \\ 0 & 0 & 0 & \lambda - a_{44} \end{bmatrix} \\ &= (\lambda - a_{11})(\lambda - a_{22})(\lambda - a_{33})(\lambda - a_{44}) \end{aligned}$$

Thus, the characteristic equation is

$$(\lambda - a_{11})(\lambda - a_{22})(\lambda - a_{33})(\lambda - a_{44}) = 0$$

and the eigenvalues are

$$\lambda = a_{11}, \quad \lambda = a_{22}, \quad \lambda = a_{33}, \quad \lambda = a_{44}$$

which are precisely the diagonal entries of A . 

 **EXAMPLE 5 Eigenvalues of a Lower Triangular Matrix**

By inspection, the eigenvalues of the lower triangular matrix

$$A = \begin{bmatrix} \frac{1}{2} & 0 & 0 \\ -1 & \frac{2}{3} & 0 \\ 5 & -8 & -\frac{1}{4} \end{bmatrix}$$

are $\lambda = \frac{1}{2}$, $\lambda = \frac{2}{3}$, and $\lambda = -\frac{1}{4}$. 

The following theorem gives some alternative ways of describing eigenvalues.

THEOREM 5.1.3 *If A is an $n \times n$ matrix, the following statements are equivalent.*

- (a) λ is an eigenvalue of A .
- (b) λ is a solution of the characteristic equation $\det(\lambda I - A) = 0$.
- (c) The system of equations $(\lambda I - A)\mathbf{x} = \mathbf{0}$ has nontrivial solutions.
- (d) There is a nonzero vector \mathbf{x} such that $A\mathbf{x} = \lambda\mathbf{x}$.

Symmetric, Skew-Symmetric, and Orthogonal Matrices

Symmetric, Skew-Symmetric, and Orthogonal Matrices

A *real* square matrix $\mathbf{A} = [a_{jk}]$ is called
symmetric if transposition leaves it unchanged,

$$(1) \quad \mathbf{A}^T = \mathbf{A}, \quad \text{thus} \quad a_{kj} = a_{jk},$$

skew-symmetric if transposition gives the negative of \mathbf{A} ,

$$(2) \quad \mathbf{A}^T = -\mathbf{A}, \quad \text{thus} \quad a_{kj} = -a_{jk},$$

orthogonal if transposition gives the inverse of \mathbf{A} ,

$$(3) \quad \mathbf{A}^T = \mathbf{A}^{-1}.$$

Symmetric, Skew-Symmetric, and Orthogonal Matrices

The matrices

$$\begin{bmatrix} -3 & 1 & 5 \\ 1 & 0 & -2 \\ 5 & -2 & 4 \end{bmatrix}, \quad \begin{bmatrix} 0 & 9 & -12 \\ -9 & 0 & 20 \\ 12 & -20 & 0 \end{bmatrix}, \quad \begin{bmatrix} \frac{1}{\sqrt{2}} & \frac{1}{\sqrt{2}} & \frac{1}{\sqrt{2}} \\ -\frac{1}{\sqrt{2}} & \frac{1}{\sqrt{2}} & \frac{1}{\sqrt{2}} \\ \frac{1}{\sqrt{2}} & \frac{1}{\sqrt{2}} & -\frac{1}{\sqrt{2}} \end{bmatrix}$$

are symmetric, skew-symmetric, and orthogonal, respectively, as you should verify. Every skew-symmetric matrix has all main diagonal entries zero. (Can you prove this?)

Any real square matrix \mathbf{A} may be written as the sum of a symmetric matrix \mathbf{R} and a skew-symmetric matrix \mathbf{S} , where

$$(4) \quad \mathbf{R} = \frac{1}{2}(\mathbf{A} + \mathbf{A}^T) \quad \text{and} \quad \mathbf{S} = \frac{1}{2}(\mathbf{A} - \mathbf{A}^T).$$

Illustration of Formula (4)

$$\mathbf{A} = \begin{bmatrix} 9 & 5 & 2 \\ 2 & 3 & -8 \\ 5 & 4 & 3 \end{bmatrix} = \mathbf{R} + \mathbf{S} = \begin{bmatrix} 9.0 & 3.5 & 3.5 \\ 3.5 & 3.0 & -2.0 \\ 3.5 & -2.0 & 3.0 \end{bmatrix} + \begin{bmatrix} 0 & 1.5 & -1.5 \\ -1.5 & 0 & -6.0 \\ 1.5 & 6.0 & 0 \end{bmatrix}$$

Eigenvalues of Symmetric and Skew-Symmetric Matrices

- (a) *The eigenvalues of a symmetric matrix are real.*
- (b) *The eigenvalues of a skew-symmetric matrix are pure imaginary or zero.*

Stretching of an Elastic Membrane

An elastic membrane in the x_1x_2 -plane with boundary circle $x_1^2 + x_2^2 = 1$ (Fig. 158) is stretched so that a

point $P: (x_1, x_2)$ goes over into the point $Q: (y_1, y_2)$ given by

$$(1) \quad \mathbf{y} = \begin{bmatrix} y_1 \\ y_2 \end{bmatrix} = \mathbf{Ax} = \begin{bmatrix} 5 & 3 \\ 3 & 5 \end{bmatrix} \begin{bmatrix} x_1 \\ x_2 \end{bmatrix}; \quad \text{in components,} \quad \begin{aligned} y_1 &= 5x_1 + 3x_2 \\ y_2 &= 3x_1 + 5x_2. \end{aligned}$$

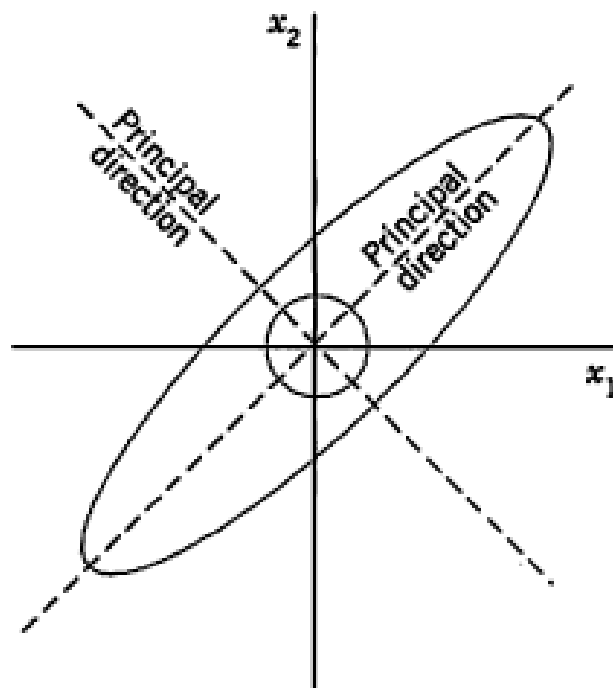

Fig. 158. Undeformed and deformed membrane in Example

Find the **principal directions**, that is, the directions of the position vector \mathbf{x} of P for which the direction of the position vector \mathbf{y} of Q is the same or exactly opposite.

What shape does the boundary circle take under this deformation?

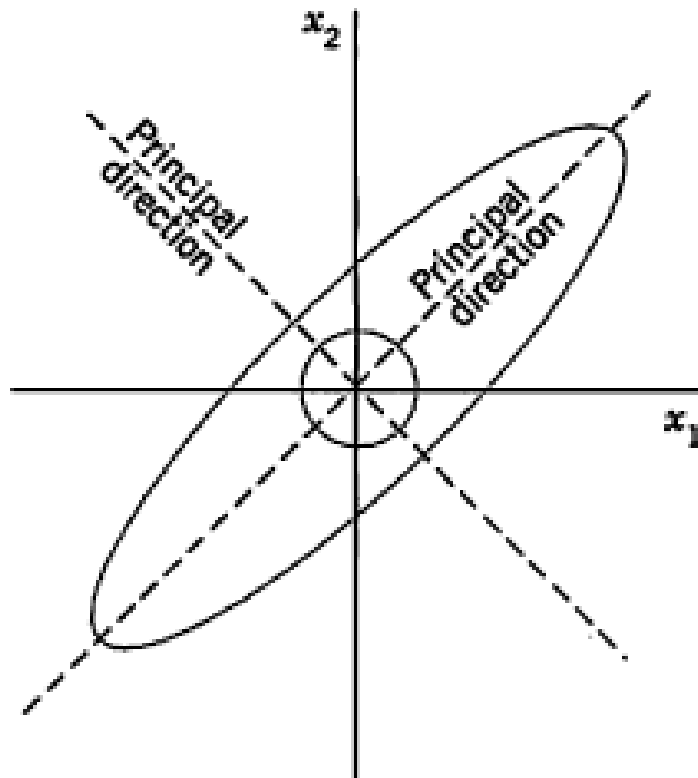

Fig. 158. Undeformed and deformed membrane in Example

Solution.

We are looking for vectors \mathbf{x} such that $\mathbf{y} = \lambda\mathbf{x}$.

Since $\mathbf{y} = \mathbf{Ax}$, this gives $\mathbf{Ax} = \lambda\mathbf{x}$, the equation of an eigenvalue problem.

In components, $\mathbf{Ax} = \lambda\mathbf{x}$ is

$$(2) \quad \begin{array}{l} 5x_1 + 3x_2 = \lambda x_1 \\ 3x_1 + 5x_2 = \lambda x_2 \end{array} \quad \text{or} \quad \begin{array}{l} (5 - \lambda)x_1 + 3x_2 = 0 \\ 3x_1 + (5 - \lambda)x_2 = 0. \end{array}$$

The characteristic equation is

$$(3) \quad \begin{vmatrix} 5 - \lambda & 3 \\ 3 & 5 - \lambda \end{vmatrix} = (5 - \lambda)^2 - 9 = 0.$$

Its solutions are $\lambda_1 = 8$ and $\lambda_2 = 2$. These are the eigenvalues of our problem.

For $\lambda = \lambda_1 = 8$, our system (2) becomes

$$\begin{array}{l|l} -3x_1 + 3x_2 = 0, & \text{Solution } x_2 = x_1, \quad x_1 \text{ arbitrary,} \\ 3x_1 - 3x_2 = 0. & \text{for instance, } x_1 = x_2 = 1. \end{array}$$

For $\lambda_2 = 2$, our system (2) becomes

$$\begin{array}{l|l} 3x_1 + 3x_2 = 0, & \text{Solution } x_2 = -x_1, \quad x_1 \text{ arbitrary,} \\ 3x_1 + 3x_2 = 0. & \text{for instance, } x_1 = 1, x_2 = -1. \end{array}$$

We thus obtain as eigenvectors of A , for instance, $[1 \ 1]^T$ corresponding to λ_1 and $[1 \ -1]^T$ corresponding to λ_2 (or a nonzero scalar multiple of these).

These vectors make 45° and -45° angles with the positive x_1 -direction.

They give the principal directions, the answer to our problem.

The eigenvalues show that in the principal directions the membrane is stretched by factors 8 and 2, respectively; see Fig. 158.

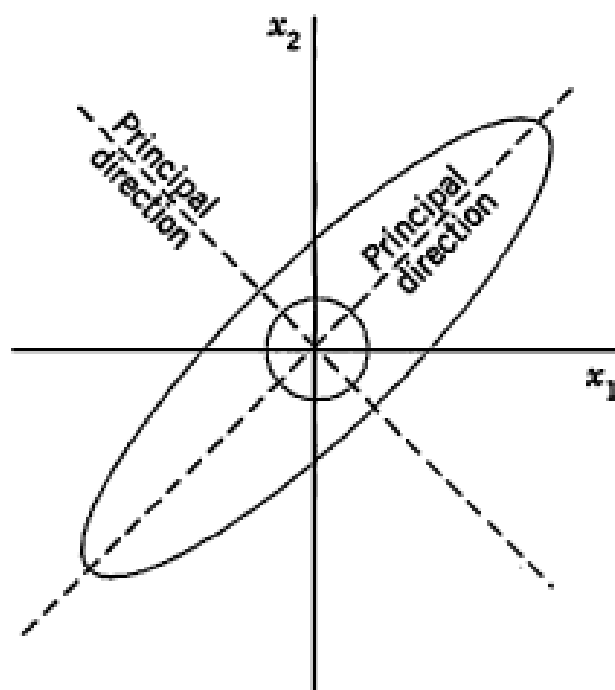

Fig. 158. Undeformed and deformed membrane in Example

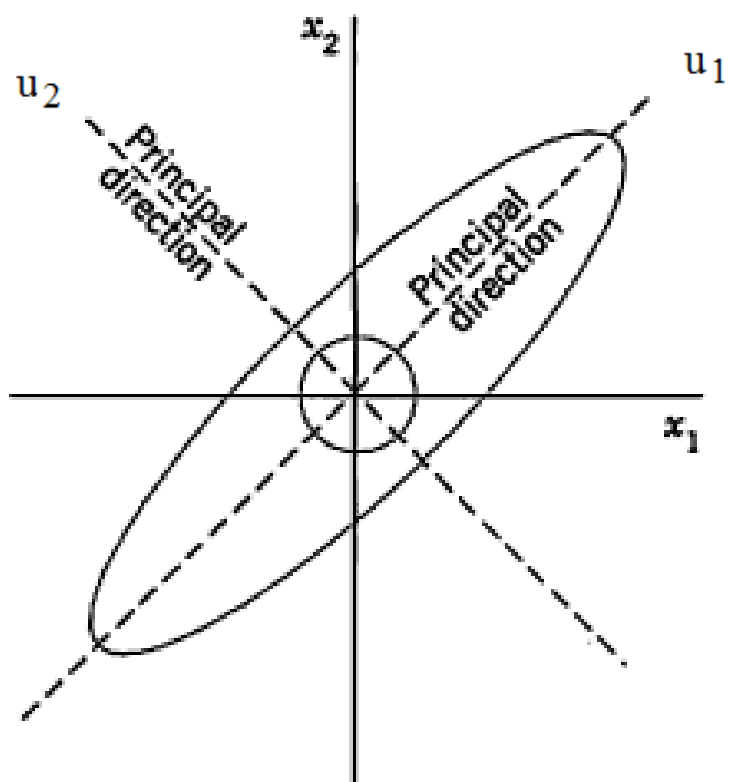

Fig. 158. Undeformed and deformed membrane in Example

Accordingly, if we choose the principal directions as directions of a new Cartesian u_1u_2 -coordinate system, say, with the positive u_1 -semi-axis in the first quadrant and the positive u_2 -semi-axis in the second quadrant of the x_1x_2 -system,

and if we set $u_1 = r \cos \phi$, $u_2 = r \sin \phi$,
then a boundary point of the unstretched circular
membrane has coordinates $\cos \phi$, $\sin \phi$.

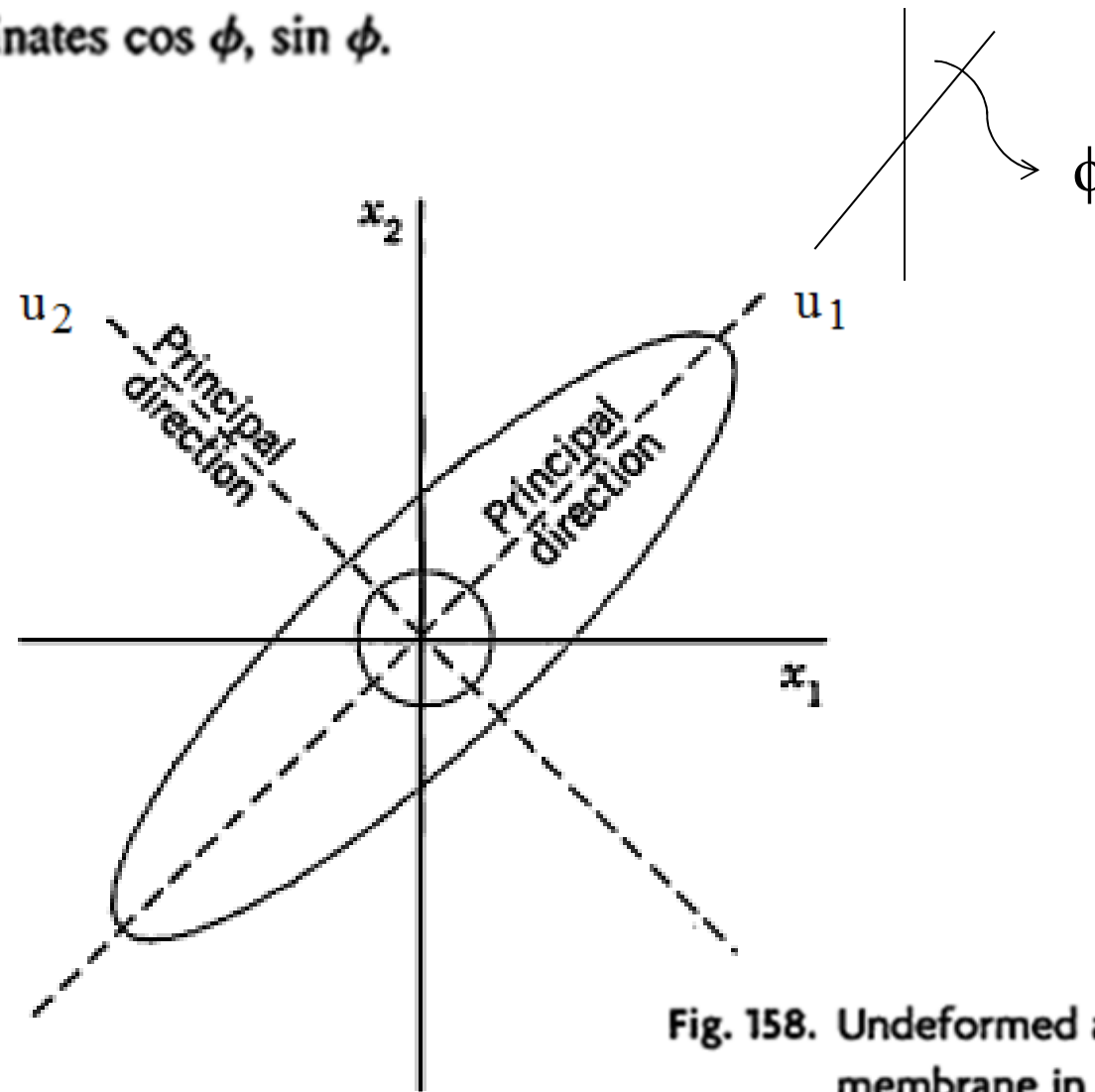

Fig. 158. Undeformed and deformed
membrane in Example

Hence, after the stretch we have $z_1 = 8 \cos \phi$, $z_2 = 2 \sin \phi$.

Since $\cos^2 \phi + \sin^2 \phi = 1$, this shows

that the deformed boundary is an ellipse (Fig. 158)

$$(4) \quad \frac{z_1^2}{8^2} + \frac{z_2^2}{2^2} = 1.$$

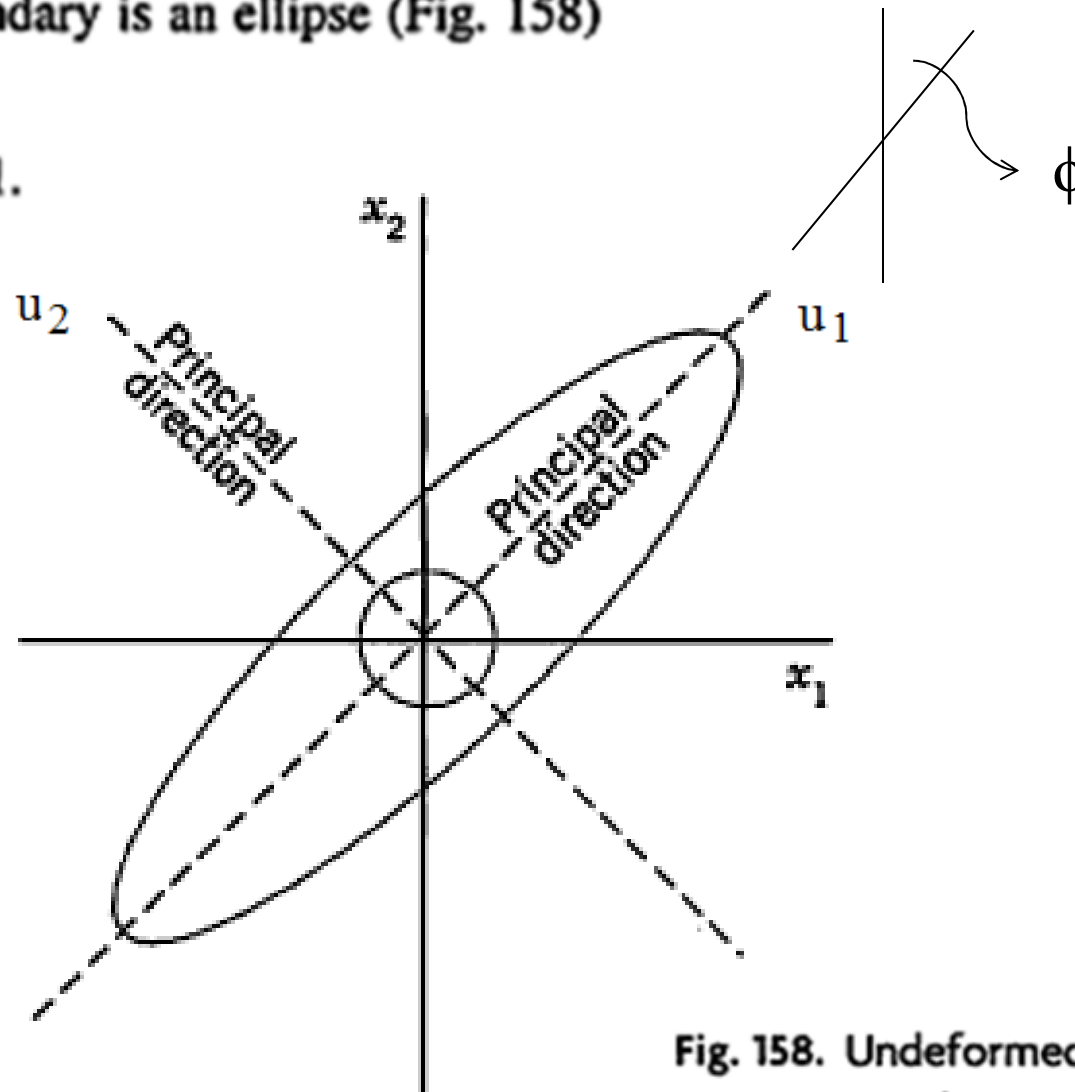

Fig. 158. Undeformed and deformed membrane in Example



Historical Note Methods of linear algebra are used in the emerging field of computerized face recognition. Researchers are working with the idea that every human face in a racial group is a combination of a few dozen primary shapes. For example, by analyzing three-dimensional scans of many faces, researchers at Rockefeller University have produced both an average head shape in the Caucasian group—dubbed the **meanhead** (top row left in the figure to the left)—and a set of standardized variations from that shape, called **eigenheads** (15 of which are shown in the picture). These are so named because they are eigenvectors of a certain matrix that stores digitized facial information. Face shapes are represented mathematically as linear combinations of the eigenheads.

[Image: © Dr. Joseph J. Atick, adapted from *Scientific American*]



Additional applications of eigenvalues and eigenvectors

- Chaotic phenomena;
- Genetics;
- Principal component analysis.